

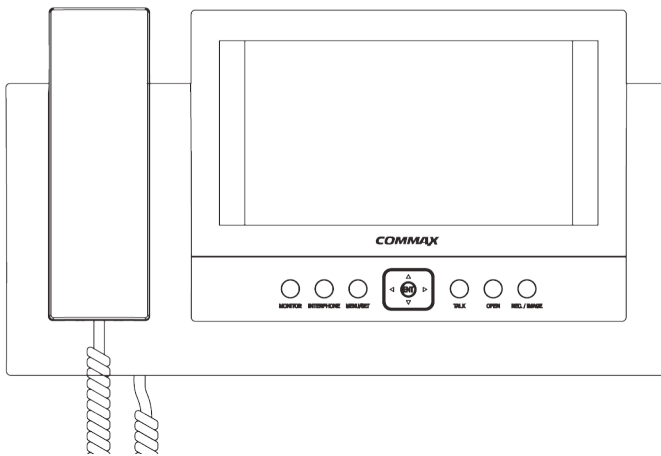

COLOR VIDEO DOOR PHONE

Model No. CAV-72B



DECT Phone (CDT-180)

COMMAX Co.,Ltd.

- Thank you for purchasing our COMMAX product.
- Please carefully read this User's Guide (in particular, precautions for safety) before using the product and follow the instructions to use your product exactly.
- The company is not responsible for any safety accidents caused in abnormal operation of the product.

Table of Contents

Warnings and caution	2
CAV-72B Part Name & Function	4
Features and Main Functions	5
CDT-180 Part Name & Function	6
Package contents	7
System Layout	8
Wiring Diagram	9
Installation Method	11
Operating Description	12
1. Door Answering & Monitoring	12
2. Interphone	13
3. Connecting the Main Unit and the DECT Phone	14
Menu/ Set	14
1. Burglar function	14
2. ROOM ID setting	15
3. Interphone Pause	15
3. Screen Adjustment	16
4. DECT Phone Registration	17
(REC./IMAGE) Image Memory	18
1. Playback	18
2. Time Set	19
3. Auto Record	19
4. Erasing All Memory	19
Trouble shooting	20
Specifications	21

Warnings and caution

◎ Make sure to follow the instructions to prevent any danger or property losses.



Warning
Death or serious injury is expected.

- It indicates prohibition.
- It indicates prohibition of disassembly.
- It indicates prohibition of contact.
- It indicates dos and don'ts.
- It indicates that the plug should be pulled out from the socket.



Warning

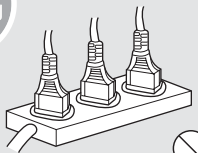

Do not put the plug in the socket simultaneously.
It may generate abnormal heat or cause a fire.

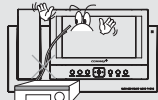

Do not connect to other products while in use.
It may cause breakdown.



Do not forcibly bend the cord or put a heavy object on the product.
It may cause a fire.



Do not use water, thinner or a detergent used to wash oil products when you wash the exterior.
Make sure to wash it by using a dry cloth to prevent any breakdown or electric shock.



Do not install the product in a humid place.
It may cause an electric shock or a fire.



Do not forcibly pull out the cord from the socket.
If the cord is damaged, it may cause a fire or an electric shock.

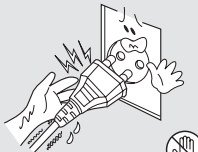

Do not put the plug in the socket with a wet hand.
It may cause an electric shock.

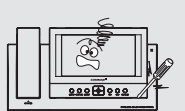

Do not disassemble, repair or modify the product.
It may cause a fire, an electric shock or an injury due to malfunction of the product.

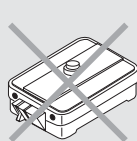

Do not use AC circuit breaker.
It may cause an electric shock.

Warnings and caution



Caution
An injury or property losses are expected

- It indicates prohibition.
- It indicates prohibition of disassembly.
- It indicates prohibition of contact.
- It indicates dos and don'ts.
- It indicates that the plug should be pulled out from the socket.



Caution

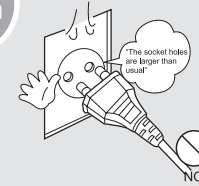

If the socket holes are larger than normal, do not put the plug.
It may cause an electric shock or a fire.

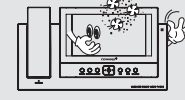

Make sure that dust or foreign substances are not gathered on the product.

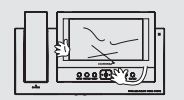

Make sure to prevent foreign substances from entering the product.
It may cause a breakdown.



Do not put a heavy object on the product.
It may cause a breakdown.



Do not disassemble or give an impact to the product.



Avoid direct rays of the sun or heating devices at a time of installation.

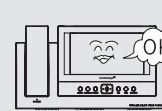

Install the product in a flat and stable place.
Otherwise, it may not function properly.

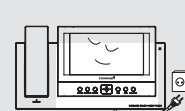

Pull the plug if the product is not used for a long time.

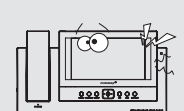

If the product generates strange sound, make sure to pull the plug immediately and contact Commax service center.

1. CAV-72B The Function and Name of Each Part

► function

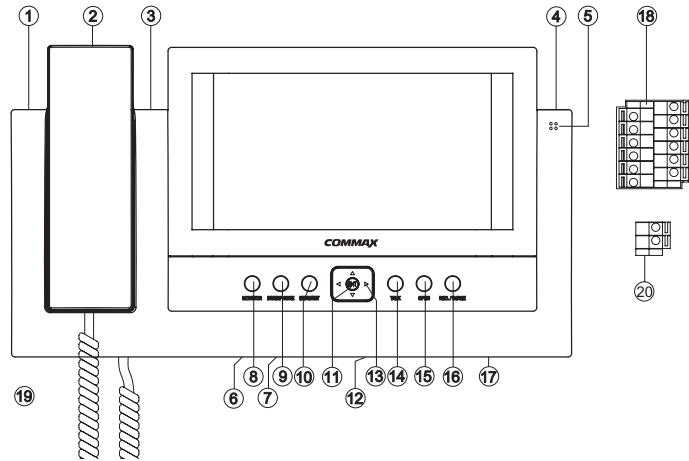

No.	Name	Details
1	Lamp, while using DECT phone	Indicate that DECT phone is under usage.
2	Handset	The phone's handset receiver
3	Security/ Automatic recording lamp	RED lamp for security, GREEN lamp for automatic recording set.
4	Power lamp (mood lamp)	Mood lamp for night
5	Microphone	Microphone for speaker phone communication
6	Volume control for call button	Control volume of call button
7	Volume control of talk button	Control volume of talk button
8	MONITOR	Check visitor's image and talk to visitor
9	INTERPHONE	Talk between rooms
10	Menu/Set	Set Burglar, Room ID, Reject interphone, DECT phone ID

2. Features and main Function

1. Features

- 7" Wide TFT-LCD
- Surface type
- Free voltage power source
- OSD (On screen Display)

2. Main function

- Door Answering & Monitoring
- Interphone call
- Image storing 128 cuts : Auto & Manual record
- Door Open function
- CCTV Camera connectable
- 4 Door camera units (Inter-connectable with door cameras or CCTV cameras) & 1 interphone connectable
- Security function (Burglar 4 zones)

No.	Name	Details
11	ENT	Execute function
12	Power switch	Control the power supply of product
13	UP/DOWN/LEFT/RIGHT	Directional keys for Up, Down, Left and Right
14	TALK	Talk with entrance camera and other room
15	OPEN	Open the door.
16	REC./DEL.	Record an image
17	Speaker	Speaker
18	Terminal (INPUT/OUTPUT/TEL)	Input and Output terminal
19	S-Cord	Connect monitor and handset
20	TEL	Terminal to connect with telephone line

3. CDT-180 The Function and Name of Each Part

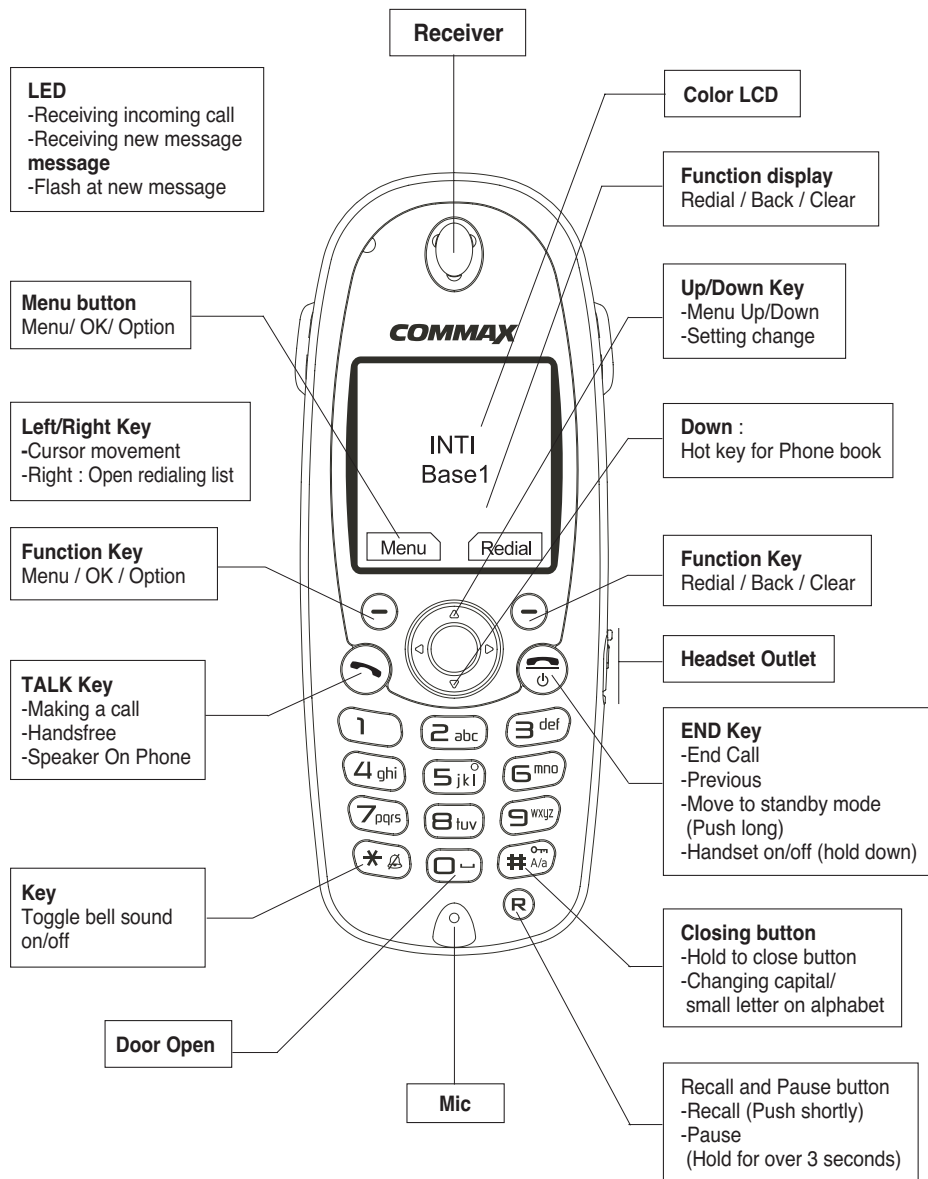

4. Package Contents

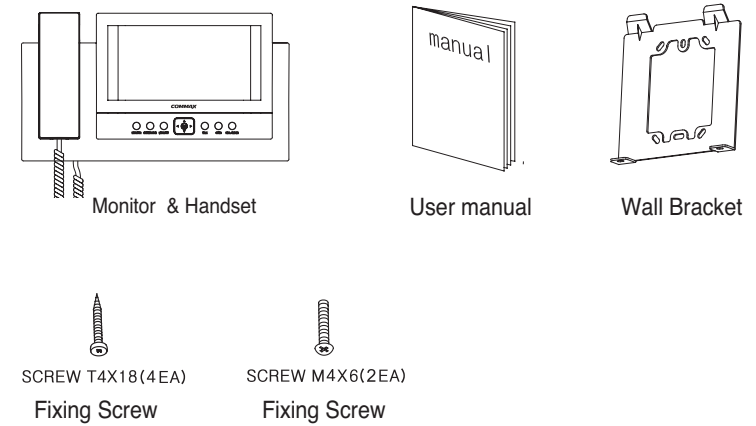

■ DECT Wireless Phone (CDT-180)

1. Additional CDT-180 purchase is required
2. Contents
 - Battery
 - Adapter

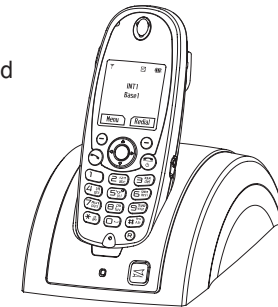

5. System Layout

▶ images

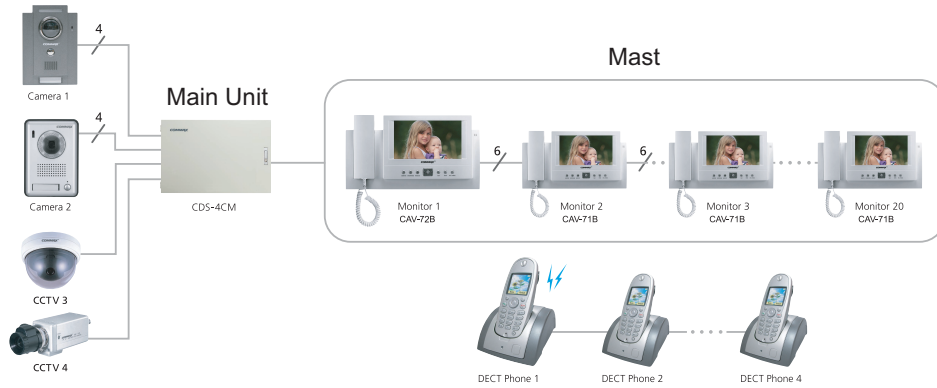

• Connectable Products.

- ① Camera : Max. 4EA
- ② Main distributor : 1EA
- ③ Master Unit: Max. 20 EA (Can connect up to 5 units per port in the main distributor)
- ④ Dect Phone : Max. 4 EA

• Wiring

- ① Main distributor To door Camera : 50M(at $\varnothing 0.65\text{mm}$)
- ② Main distributor To Monitor : 20M (at $\varnothing 0.5\text{mm}$)
- ③ Main distributor to CCTV Camera : Coaxial Cable

6. Wiring Diagram

▶ images

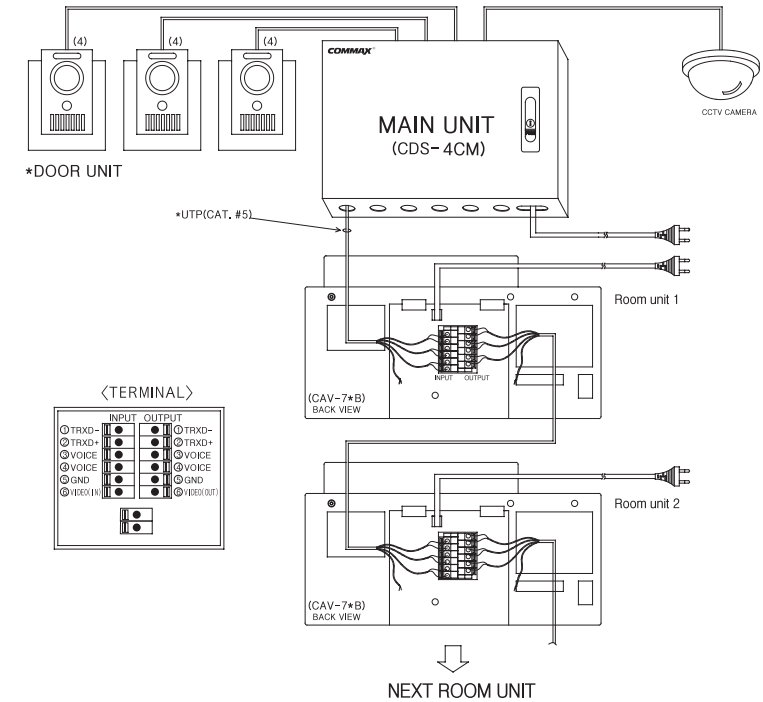

• CAUTION

- The monitor can connect up to 5 EA per port from the main distributor.
- Be careful of the polarity.
- It is recommended to use UTP(CAT. 5) but it is possible to use from 26AWG to 20AWG.

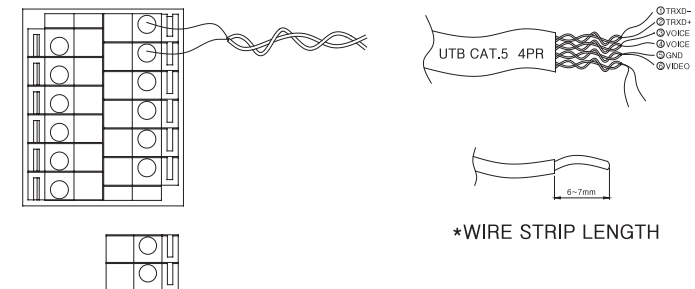

- Please be careful of the polarity as the shown in the picture.

- Wiring between CCTV Camera to Main Distributor
- All ports for the camera on the main distributor are available for using the CCTV or Door Camera units.
- Power source is separately required per CCTV Camera
- The type of Coaxial Cable depends on the distance of installation.

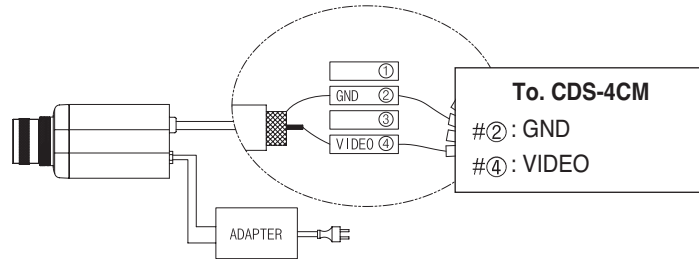

7. Installation method

► Installation method of monitor

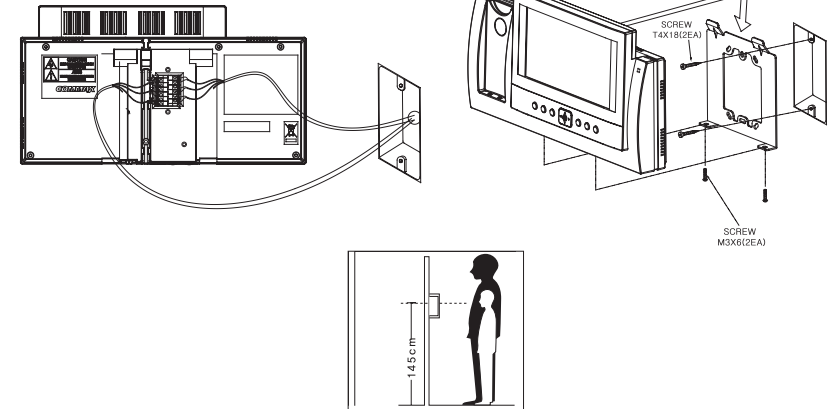

• CAUTION

- Avoid installing this product where there is magnetic force, humidity, direct exposure under the sun and near heating apparatus.
- The recommendable installation height for CAV-72B is 1450 ~ 1500mm.
- It is better for DECT phone to be charged after finishing installation.

► Installation method of camera (at DRC-4CH)

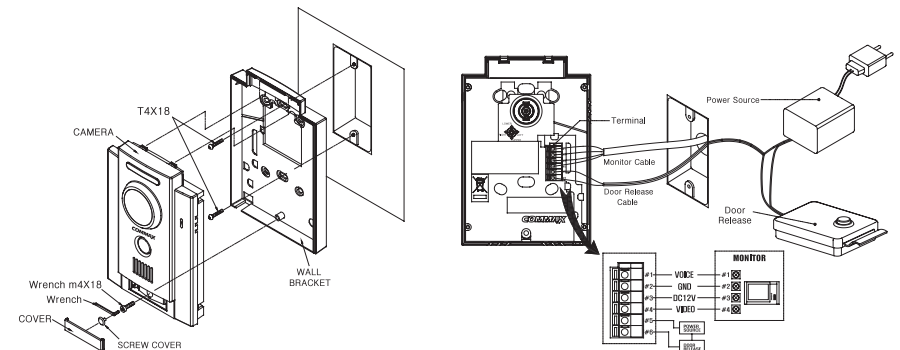

- Keep this products away from direct exposure from the sun or reflected light while installing.
- Picture quality may deteriorate as a result.



8. Operation Description

1) Door Answering & Monitoring

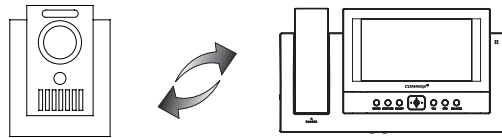

- ① When you push the CALL button on camera, you can hear the chime sound from the monitor and visitor's image will be shown on a screen
OSD : [Cam1 call] * Duration of on-screen: 30 Seconds
- ② To talk to visitor, push the TALK button and then you can talk in the hands-free mode.
- ③ If you pick up the handset, you can talk with the visitor through the handset.
OSD : [Cam1 call talk] * Duration of talking: 1 minute
- ④ To see the condition of door in standby, press the MONITOR button and if you push the RIGHT(▷), to see the screen of the next camera.
At this time, if you do not set the camera connection in the deep switch of main unit, the camera channel will be passed.
- ⑤ While you are talking and monitoring, push the OPEN button to open. **OSD : [Cam1 talk open]**
- ⑥ While you are talking and monitoring with door camera, push the REC/ IMAGE button and 1 image will be taken. **OSD : [Cam1 talk rec]**
- ⑦ While talking in hands-free mode, push the MONITOR button to end the talk with door camera. While talking through the handset, hang up the handset to end the talk with door camera.

2) Interphone

♣ This function is to call to other room unit and talk with other room unit.

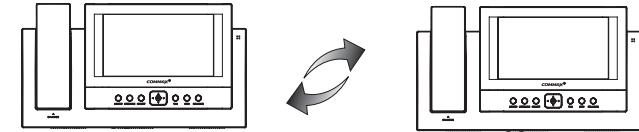

- If you push the INTERPHONE button, each room ID will be shown in the form of [Room#] as below.

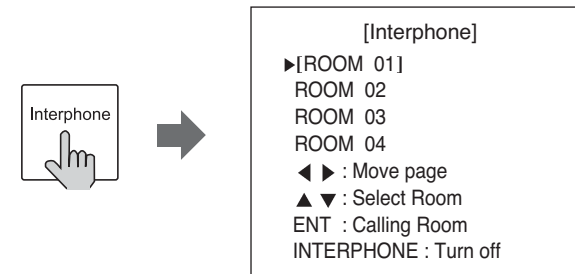

- ① After placing an arrow mark on the certain room number using the UP/DOWN button, the ring sound will be heard in the room.
- ② If you push the TALK button or pick up the phone, you can talk with other room.
 - ※ Each room number has its own registration (ie. ROOM 1) and can not call to itself.
 - ※ "Interphone Pause" In case of calling to reject a set room number, "Interphone Pause" will be shown
OSD : [Interphone pause Room#]
- ③ If you push the ENTER button, the call chime sound will be heard in the called room.
OSD : [Call Room02] Room : [Call from Room01]

3) Connecting the Main Unit and the DECT Phone

♣ This DECT phone has various functions from a normal DECT phone.

① Door Call

When you receive a call from door, pick up the DECT Phone from the adaptor and press the TALK button and you can talk, To end the talk, put down the DECT Phone to the adaptor or push the PAUSE button.

② Door open

When you are making a call with door, if you push the No. 0 button, the door will open

③ Interphone call

It is not possible to call to other room using the DECT phone

④ Receiving an Incoming Door or Interphone Call While Talking on the Phone

In case of receiving a door call or interphone call while already taking another call, you can hear another ringing sound in the handset. If you want to receive the incoming call, push the PAUSE button to end the previous call and push the TALK button to receive a new call.

⑤ Receiving an Incoming Phone Call while Talking with the Door Camera or Interphone.

You can hear another ringing sound in the handset. If you want to receive the another telephone call, push the PAUSE button to end the previous call and push the TALK button to receive a new call.

※ Because the DECT phone needs more time to analyze ring signals, it takes some more time to receive/make a call.

② Use the Right(▷) button and then select a setting using the SET(Y) button and cancel (N) button and push the ENT button to exit the MENU.

It is possible only when all magnetic switches connected to main unit are closed (holding time : 60sec)

OSD : [Burglar Y or N]

※ If "Y" is selected for setting, the red security light will flash in the upper side.

If there is a security problem is happened after completing all Burglar function setting, there will be certain holding time and a siren alarm will be made with OSD message.

(Holding time to release : 30 seconds)

OSD : [WARNING! INVASION]

③ To release, press the ENT button according to OSD MENU

④ The restore is available only when all magnetic switches connected to main unit is closed

2) ROOM ID setting

① After getting in the ROOM ID mode using the MENU/SET button and placing the

▶ mark on required room number and push the ENT button to get out from the MENU.

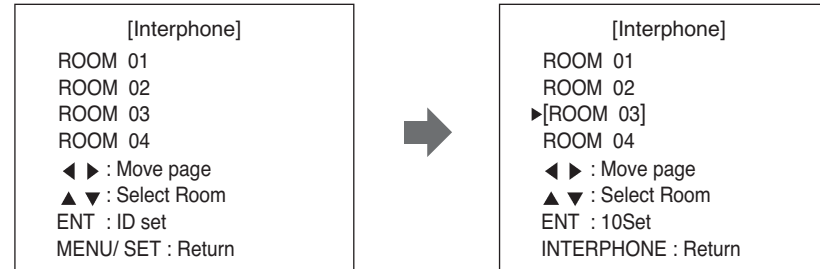

3) Interphone Pause

① After selecting the INTERPHONE PAUSE mode use the MENU/SET button and select the SET(Y) button and cancel (N) button and push the ENT button to get out from the MENU.

OSD : [Interphone pause Y or N]

9. MENU/ SET

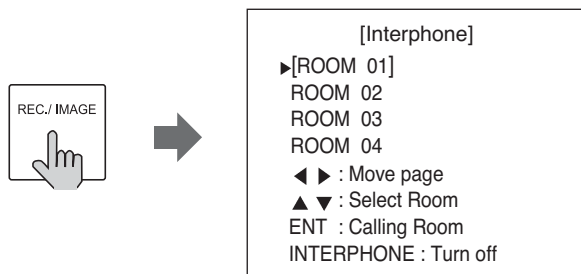

1) Burglar function

① Press the MENU/SET button and move to Burglar mode using the ◀▽ button and ENT button.

4) Screen Adjustment

Screen Adjustment

- Press the MENU/SET button and scroll through the video level adjusting options using the (Δ▽) buttons and ENT button.
- Press the ENT button once more and a certain picture will be displayed. Input the desired adjustments using the (Δ▽) buttons and the ENT button.

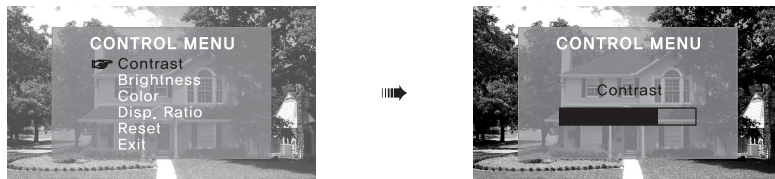

- To access other items on the control menu, press the MENU/SET button and adjust in the same manner
- If you wish to change the ratio size of the screen, select 'Disp. Ratio' from the menu and press the ENT button. Use the (<D>) keys to change the ratio.

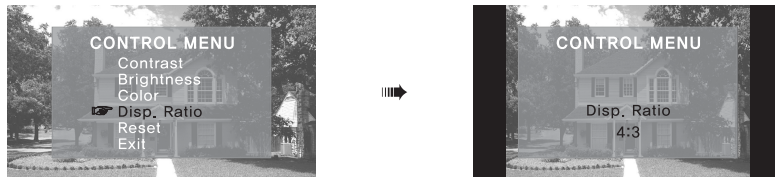

- If you want to change the initial value for the video level adjustment, push the ENT button after selecting 'Reset', and the value will return to its default setting.

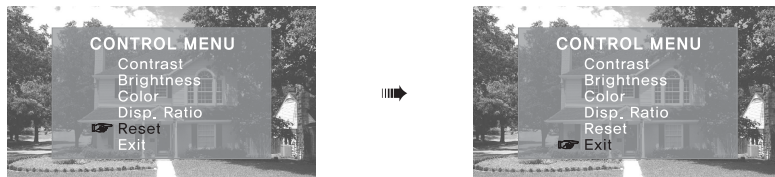

- If all video level adjustments are completed, push the ENT button after selecting Exit.
 - ※ Screen adjustment is possible for 30 seconds after accessing the menu.

5) DECT Phone Registration

- ① Before usage of any wireless phone, each phone must be registered with the DECT base unit.

Registering a Wireless Phone

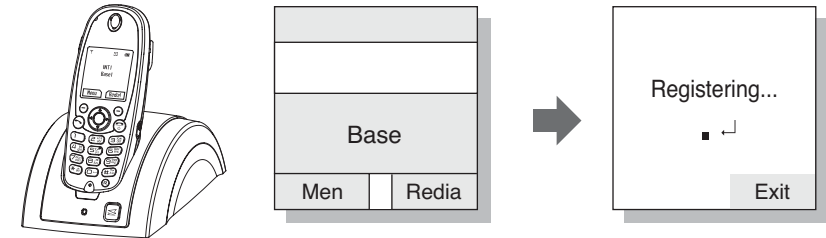

- ② Menu >> Handset Set >> Register >> Base # ID >> Enter PIN (Personal Identification Number: 4-digits) then press the OK button. The phone will then be registered in the body of the DECT base.
- ③ Next, program the registration mode from the body.

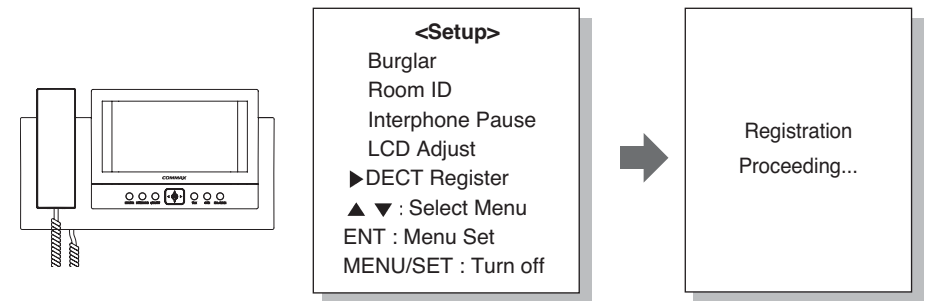

- ④ By pressing the MENU/SET button, choose 'DECT Register' and press ENTER to register any phone.

♣ Phone Successfully Registered

- ① When the registration of a phone is complete, a "beep" will sound and the numbers 1-6 will appear. At this time, register any desired number 1-6 to the phone. (*Any previously registered number will not appear on screen.)
 - ※ One DECT base is capable of registering up to 6 wireless phones.
 - ※ The registration may take anywhere from 5 ? 60 seconds to process.
 - ※ If the phone fails to register, wait 1 minute before trying to register it again.

10. (REC./IMAGE) Image Memory

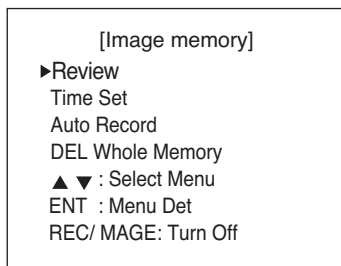

1) Playback

- ① Press the REC./IMAGE button
- ② Use the UP,DOWN keys to select the Review mode/option and press ENTER



- ③ Use the RIGHT(>) key to scroll through the images of each of the six screens in sequence.
- ④ Press ENTER to view one image in full-screen mode, and press the Right(>) to scroll to view the next image in full-screen.



2) Time Set

- ① Press the REC./IMAGE button.
- ② Use the UP,DOWN keys to select the 'Time Set' mode and press ENTER.
- ③ Use the LEFT,RIGHT keys to advance through the time setting options and use the UP,DOWN keys to change the value of the desired option.
- ④ Press the ENTER button to save the time setting and press REC./IMAGE to exit the menu.

Time set
23-JUN-07 11:12:33
▲
Day Set
Complete : ENT

3) Auto Record

- ① When a visitors rings the door bell, the camera will automatically capture and save one image of the visitor.
- ② Press the REC./IMAGE button.
- ③ Use the UP/DOWN keys to select the 'Auto Record' mode and press ENTER.
OSD : [Auto Record Y or N] will display on screen.
- ④ Use the Right(>) to select YES or NO
- ⑤ Press the REC./IMAGE button to exit the menu.

※ If you selected YES, the light at the top of the monitor will blink green in one second intervals.

♣ A total of 128 images can be stored in the system's memory. If more images are taken, the first image will automatically delete to make room for the new image, and so forth.

4) Erasing All Memory

- ① This function will delete all saved images from the system's memory.
- ② Press the REC./IMAGE button.
- ③ Use the UP,DOWN keys to select the 'DEL Whole Memory' mode and press ENTER.

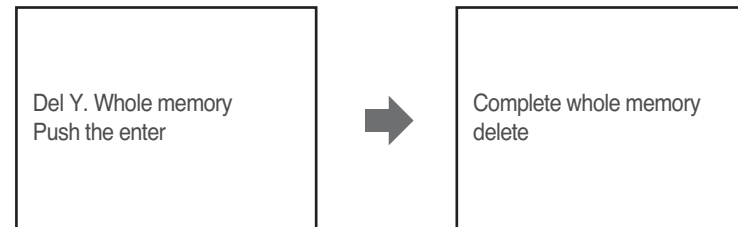

- ④ Press the Right(>) button and ENTER to confirm the deletion of all saved images.
- ⑤ Press the REC./IMAGE button to exit the menu.

11. Trouble shooting

If you think that the product has trouble, please first check below contents before you ask a repair.

Troubles	Check Point	Actions
<ul style="list-style-type: none"> The power supply is not on. All works are stopped 	<ol style="list-style-type: none"> The power supply code is missing or not. The power supply switch (down) is off or not. 	<ol style="list-style-type: none"> Please connect the power supply cord Please turn on the power supply switch (down) pushing to the right.
<ul style="list-style-type: none"> A Call operation is not performed. (Door, Interphone function) 	<ol style="list-style-type: none"> The wiring between other units is connected correctly in good order or not. The wiring is missing or not. A Room id is set or not. 	<ol style="list-style-type: none"> Please refer to connection related page and manage. Please connect correctly to the terminal. Please refer to Room id setting related page.
<ul style="list-style-type: none"> The product does not produce the sound. (Call volume, Talk volume) 	<ol style="list-style-type: none"> A sound volume lies in minimum or not. 	<ol style="list-style-type: none"> Please adjust the sound volume properly turning to the right, as you want.
<ul style="list-style-type: none"> The screen is dark. The screen is strange. 	<ol style="list-style-type: none"> There is a strong reflected light behind the visitor or not. The screen control is adjusted correctly. 	<ol style="list-style-type: none"> Please change the angle of camera lens. Please initialize the screen control. (Refer to setting related page)
<ul style="list-style-type: none"> We can see the visitor image but no voice. 	<ol style="list-style-type: none"> The connector on the handset is properly inserted to the product? 	<ol style="list-style-type: none"> Please put the connector properly again.
<ul style="list-style-type: none"> No stored image found 	<ol style="list-style-type: none"> Auto recording is assigned? 	<ol style="list-style-type: none"> Please set the status of "AUTO RECORD" as "YES"

12. Specification

ITEM	CAV-72B	
Wiring number	Central unit: 6 wires, MASTER : 6 wires, TEL: 2 wires	
Rated voltage	AC100-240V~, 50/60Hz	
Talk method	HANDS-FREE : Voice switch method , HANDSET(Wire) *Option : DECT	
Display unit	7" TFT-LCD	
Call sound	Door(individual door):ring electronic chime 3 sounds twice repeatedly, Interphone : electronic melody sound	
Power consumption	On operating: 11W	
Communication distance	Central unit to MASTER : 20m/ \varnothing 0.5(CAT. 5)	
	MASTER to MASTER : 20m/ \varnothing 0.5(CAT. 5)	
Wireless handset	Modulation	TDMA/FSK
	Frequency band	1.880GHz ~ 1.900GHz (DECT)
	Communication distance	5M
Talk channel	1 channel	
Temperature	0°C~+40°C (32°F~104°F)	
Dimension	315(W)x175(H)x53(D)	
Weight	1.7kg	

COMMAX

Blooming Life, HomeNetwork

COMMAX Co.,Ltd.

a513-11, Sangdacwon-dong, Jungwon-gu, Seongnam-si, Gyeonggi-do, Korea

Int'l Business Dept. : Tel.; +82-31-7393-540~550 Fax.; +82-31-745-2133

Web site : www.commax.com

Printed In Korea/2007.10