

# User Manual

Color video door phone CDV-70UM



- Thank you for purchasing COMMAX products.
- Please carefully read this User's Guide (in particular, precautions for safety) before using a product and follow instructions to use a product exactly.
- The company is not responsible for any safety accidents caused by abnormal operation of the product.

## Greetings









- Thank you for choosing COMMAX.
- Please read this manual carefully before you use the product.

## Table of contents

Greetings .....	1
Contents table .....	1
1. Warnings and caution .....	2
2. Product Overview .....	4
3. How to use this product .....	6
4. GUI Function .....	12
5. Wiring methods .....	31
6. Components .....	32
7. Caution in use .....	33
8. Miscellaneous .....	33
9. Specification .....	33

# 1. Warnings and caution

Please follow the things described below in order to prevent any danger or property damage.

 <p><b>Warning</b> It may cause a serious damage or injury if violated.</p>	 Prohibition.
 <p><b>Caution</b> It may cause a minor damage or injury if violated.</p>	 No disassembly
	 No touch
	 Must follow strictly.
	 Shows plugging out the power cord without an exception
	 Shows the warning and caution for an electric shock.
	 Shows the warning and caution for a fire.

## Warning

### Power & Installation

Please don't use several products at the same time on one power socket.  
· It may cause a fire due to an abnormal overheating.



Please don't bend the power cable excessively or it may cause an electric shock.  
· fire when using a damaged power cable.

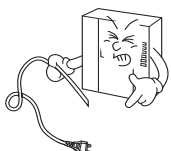

Please don't handle the power cable with a wet hand.  
· It may cause an electric shock.



Please plug out the power cable from the socket when not using it for a long period of time.  
· It may shorten the product lifespan or cause a fire.



Please don't install the product in the place where there is much oil, smoke or humidity.  
· It may cause an electric shock or fire.

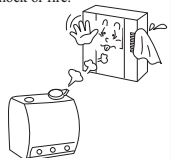

Please don't install the product with the lightning and thunder.  
· It may cause an electric shock or fire.

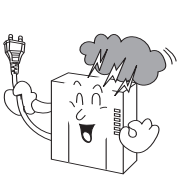

Please don't use and connect this product with other products with different rated voltage.  
· It may cause a disorder or fire.

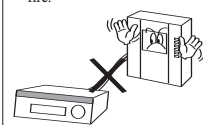

When installing the product that generates heat, please install the product away from the wall (10cm) for the ventilation.  
· It may cause a fire due to the increased internal temperature.

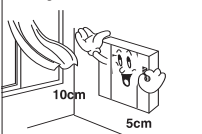

## ⚠ Warning

### Cleaning & Use

Please don't disassemble, repair or rebuild this product arbitrarily (please contact the service center if a repair is needed).

- It may cause an electric shock or fire.



If an abnormal sound, burning smell or smoke is coming out of the product, please plug out the power cable and contact a service center.

- It may cause an electric shock or fire.

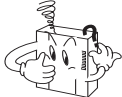

Please don't insert any metallic or burnable materials into the ventilation hole.

- It may cause an electric shock or fire.



Please use only the designated batteries for the products of using DC power.

- It may cause an electric shock or fire.



## ⚠ Caution

### Power & Installation

Please plug the power cable firmly into the inner end

- It may cause a fire.

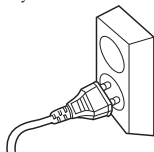

Please hold the plug tightly when unplugging the power cable (a part of the copper wire may be disconnected if the grabbing is only made on the cord when pulling out the cable).

- It may cause an electric shock or fire



When connecting the power cables after cutting the cable, please install the product with power off

- It may cause an electric shock or fire



When installing the product, please fix it firmly while using the wall-mounting unit and screws.

- It may cause an injury from the falling object.

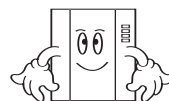

Please be careful when using an AC circuit breaker since there is a possibility of an electric shock.

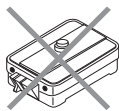

Please check the use voltage and current for the DC-only products and use the appropriate rectifier.

- It may cause a fire.

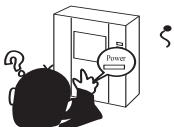

Please avoid direct rays of the sun or heating devices at a time of installation.

- It may cause a fire.

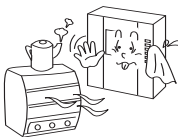

Please don't install the product on an unstable place or small support board.

- It may cause an injury if it falls down while in use.



### Cleaning & Use

When cleaning the product, please rub it with a soft and dry cloth after plugging out the power cable. (Please don't use any chemical products such as wax, benzene, alcohol or cleanser.)



Please don't drop the product on the ground and don't apply a shock.

- It may cause a failure.

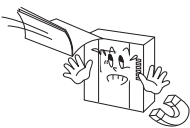

Please use the designated connection cable within the maximum calling distance designated for the product

- It may reduce the product performance.



## 2. Product Overview

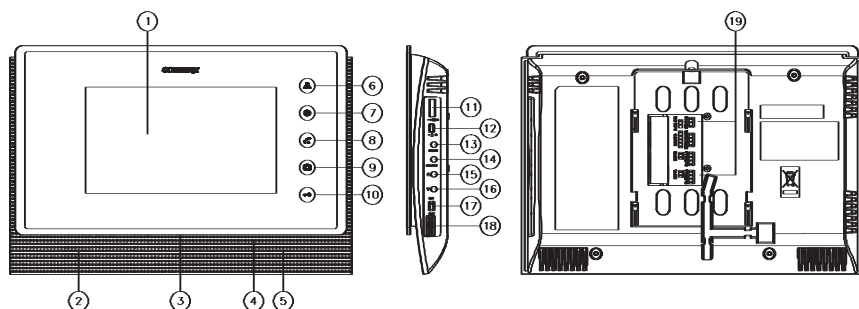

No.	Description	No.	Description
1	LCD MONITOR	11	RECEIVER VOLUME CONTROL
2	LEFT SPEAKER	12	RINGER VOLUME CONTROL
3	POWER AND MOOD LIGHTING	13	MENU BUTTON
4	MICROPHONE	14	SELECT BUTTON
5	RIGHT SPEAKER	15	UP BUTTON
6	MONITOR BUTTON	16	DOWN BUTTON
7	INTERPHONE BUTTON	17	POWER ON/OFF
8	TALK BUTTON	18	T-FLASH CARD SLOT
9	IMAGE SAVE BUTTON	19	EXTERNAL CONNECTION TERMINAL
10	DOOR RELEASE BUTTON		

### [NOTE]

#### Setting for Camera

You can set whether use camera or not using short pin on the back of the product.

You should set to use only CAMERA 1 with connecting short pin.

(Connecting Short Pin: use only Camera1/ open Short Pin : Use Camera1, Camera2)

### [Format function]

Please press 2 seconds on the right of the products Menu + Down (▼)

➔ "Format SD card? Push the key Yes[Select] or No[Menu]"

: [Menu] Button ➔ When screen turned off, it will be changed the standby mode.

[Select] Button ➔ When screen show up ' please wait, SD Format it wii be progressed format.

When melody finished it will be changed the standby mode.

※ **Caution**

Please, do not turn on/off, insert or remove Micro SD card during saving, capture image or recording video. It might be caused of malfunction, harm or damage goods. (User may lose data in embedded memory and Micro SD card or it may be reason of malfunction)

- When memorized data exceed capacity of memory in external micro SD card, product erase automatically delete oldest data because of limitation of embedded memory capacity. Therefore, we recommend user do back-up data to separate memory.
- Please, check bellow memory spec and use it. We do not guarantee proper operation and we are not under legal responsibility if user uses other memory which is not recommended by us. When you insert card please insert until the sounds.
- Recommended spec. of MICRO SD [T-FLASH] Card  
(Please, format memory first before use it)
  - 1) Manufacturer : SANDISK  
MICRO SD : 2GByte  
MICRO SDHC [CLASS 4] : 4 ~ 16GByte
  - 2) Manufacturer : TRANSCEND  
MICRO SD : 2GByte  
MICRO SDHC [CLASS 4] : 4 ~ 16GByte
- This product has ' SUPERCAP inside.  
'SUPERCAP' is for preventing data lost and damaged in memory if there is temporarily black out or lost electric power. It turns on embedded clock in period time when product lost power. Recharging ' SUPERCAP' takes over 30minutes after turning on power. It can operate embedded clock during approximately 24hours without external power. If data file is many or size of file is big, embedded clock may stop within 48hours. Therefore, user must check and set time in product when turning on product again.
- We recommend check time in product periodically because of time error or difference time.
- How to insert Micro SD [T-FLASH]  
Please, refer to below photo and pay attention to direction when Insert Micro SD card. When user inserts Micro SD card, please slide card until you feel a ' click'

















## 3. How to use this product

### 3-1. Stand-by mode

- ① When you turn on the video phone, The LED(Blue) on the bottom of LCD Display will be turned on. And then you can see a LOGO on the LCD screen, after booting sound, it will be stand-by mode.
- ② You can check model name and version information by pressing DOWN button on the right for 2 seconds in stand-by mode.

### 3-2. Operation

#### (1) To make a call

- ① When the visitor press button in stand-by mode from the entrance(door camera), electronic chime bell rings of video phone and interphone.  
And LEDs of  (monitor button) and  (talk button) blink, the image of the visitor is shown on the screen in 3 seconds. (If you press menu button, it will be disconnected and turned into stand-by mode)
- ② The screen will be turned on for 30 seconds in stand-by mode and for communication, it will be turned on for 60 seconds.
- ③ If you call interphone by pressing  (talk button) and push  (interphone button) for 3 seconds, ringtone will come out from interphone and the conversation begins if you pick up the hand set. Press talk button to end the conversation.
- ④ In order to call video phone from interphone, pick up the handset of interphone and press call button. The LED of  (interphone button) and  (talk button) will blink, ringtone will come out from the video phone and the image of interphone will also blink and off on the screen. Then, the  (interphone button) and  (talk button) will blink. If you click  (interphone button) or  (talk button), the conversation begins. If  (interphone button) or  (talk button) are not clicked, the monitor will return to standby mode.)

#### (2) VOLUME CONTROL (DOWN → UP)

- ① Adjust volume of receiver sound with receiver volume control on the side of the video phone from "small" to "loud" .
- ② Adjust volume of ringer volume with ringer volume control on the side of the video phone from "small" to "loud".

#### (3) Video format (NTSC/PAL) setting

▶ Video format between both of CCTV and CAMERA should be same.

##### a) In case of connecting CCTV(NTSC)

Push SELECT+UP buttons on side at the same time for a few seconds, it will be changed to NTSC mode.

b) In case of connecting CCTV(PAL)

Push SELECT+DOWN buttons on side at the same time for a few seconds, it will be changed to PAL mode.

※ Caution : If you change video format, the stored image in SD CARD will be deleted.

► Initialization method and changing list







a) SIDE KEY Initialization(factory initialization)

- NTSC(SELECT+UP),PAL(SELECT+DOWN)
- Color balance (BRIGHT 50/CONTRAST 50/COLOR 50)
- Language(English)
- Auto-save function (Auto-save)
- Image save mode (Still image)
- Digital album visual effects (None)
- Digital album screen timeout (5minutes)
- Proximity sensors(disable)
- Deleted saved images of SD CARD





b) Initialization of settings(user initialization)

- Color balance (BRIGHT 50/CONTRAST 50/COLOR 50)
- Language(English)
- Auto-save function (Auto-save)
- Image save mode (Still image)
- Digital album visual effects (None)
- Digital album screen timeout (5minutes)
- Proximity sensors (disable)
- Deleted saved images of SD CARD.

(4) Call Function

- ① If you press  (monitor button) in stand-by mode, LEDs of ,  (talk button) blink. By pressing , you can talk with door camera. By picking up the handset of interphone at this time, 3-way communication is possible.
- ② You can talk for 60 seconds with door camera. When the time is over, it will be stand-by mode automatically.
- ③ Click  (talk button) and  (interphone button) to call the interphone. If you pick up the handset, the talk begins.



- ① It is possible to communicate with interphone for 60 seconds, You can also extend more 60 seconds by pressing call button on the video phone or interphone. When the time is over(60 seconds), it turns to stand-by mode automatically.
- ② You can talk with CAMERA2 by calling CAMERA2 during communicating with CAMERA1, the screen will be sequentially shown from CAMERA1 to CAMERA2 when user press  (monitoring button).
- ③ When the visitor calls from the entrance(door camera) during communicating between video phone and interphone, The LEDs of  (Monitoring button) and  (talk button) blink, 3-way communication is possible by pressing  (Monitoring button) or  (talk button).

※ Press (talk button) to finish talking.

#### (5) Save image





- ① To save camera images, press (save image button) more than 1second during calling camera or monitoring mode.
- ② You can save still image is shown on the screen when you press button.
- ③ While it is saving the video clip, save image buttons will not work. The button will work after image saving is complete.
- ④ This function operates regardless of setting for recording method(Auto/manual)
- ⑤ You can use same function by pressing  (monitor button) for long when you call camera or monitoring.
- ⑥ Images are stored in SD CARD only. If you don't put in SD CARD or use defected SD CARD, saving images is not available.

#### (6) Monitoring

(The following scenario is the example that 2cameras and 2 CCTV are installed. If they are not installed as like the example, the monitoring function of relevant camera doesn't work.

- Monitoring sequence (The monitoring mode will be sequentially operated when user presses  button as follows.)

- (a) CAM1 (Full) + CCTV1 (PIP)
  - No CCTV1 signal, transferred (b)
- (b) CAM1 (Full)
- (c) CCTV1 (Full)
  - No CCTV1 signal, transferred (d)
- (d) CAM2 (Full) + CCTV2 (PIP)

- If the short pin are inserted, switched stand-by mode.
- No CCTV2 signal, transferred (e)
- (e) CAM2 (Full)
- (f) CCTV2 (Full)
  - No CCTV2 signal, switched stand-by mode
  
- Monitoring sequence during communicating
- (a) CAM1 (Full) + CCTV1 (PiP)
  - Condition: No CCTV1 signal, Only CA1 (Full) is shown.
- (b) CAM2 (Full) + CCTV2 (PiP)
  - Condition: No CCTV2 signal, Only CA2 (Full) is shown.
- (7) Door release
  - The door release works by pressing  (door release button) of video phone during being on the phone.
  - The LED  of (door release button) is turned on during releasing door.  
(In case of being installed door camera with door release function)
- (8) Save captured image
  - ※ This function apply the storage method is "Picture"  
If you set auto-save mode, it store image when there is call from camera.  
If you press  (save image button) or  (monitor button) for 1second in monitoring mode or communicating, 1 cut image will be stored after a recording icon is displayed in the screen.
- (9) Save of video
  - ※ This function apply the recording method is "video".  
It record image when there is a call from camera in auto-recording mode.  
If you set auto-save mode, it record video for 30 seconds when there is call from camera, and for 60 seconds in case of communicating. The maximum time able to record video for one time is 90 seconds(reply time for call + time for talk)

**caution 1**

- Don't remove SD card during saving of captured image and video. It may cause defect or data loss.

**caution 2**

- The recording image file is only stored in SD CARD. Please note that It is not available to record image If SD CARD was defective or not put into product.

**Folder and File management**

→ Create basic folder

- . \MOVIE\00\ (Video storage folder)
- . \PICTURE (Captured image storage folder )
- . \ALBUM (Digital album image storage folder)

When the icon is displayed, please built in data or back up into Micro SD card.



⇒ SAVE FILE and FILE FORMAT

Still image	120916_130502_D1.jpg			
	120916_130502_C2.jpg			
Video	120916_130502_D1.mp4			
	120916_130502_C1.mp4			
Details of file	Date	Time	Video Type	File Type
	12 year 9 month 16 day	13hr5min2sec	D1,D2 = Entrance 1, 2 C1,C2 = CCTV 1,2	Still image (*.jpg) Video (*.mp4)
Note	<p>⇒ It is need to keep minimum extra space of Micro SD Card Minimum space : Micro SD - 100MByte</p> <p>⇒ Save 128 cuts(MAX) of Captured images If the memory exceed capacity, the oldest file will be deleted and then save new file.</p> <p>⇒ Video can be saved in full. If not have any space for storage in Micro SD Card</p> <div style="display: flex; align-items: center;"> <p>This icon will be displayed in LCD screen.</p> </div> <p>If the icon above comes up, the oldest file will be deleted automatically to save new one. At this time, it might erase several files to make minimum extra space. So, please make a backup of your important files and save separately. The icon "SD FULL" will be disappeared if there is enough space by format internal memory and Micro SD Card, delete files. The number of files is depends on memory. Please refer to following information. If the number of files exceed maximum number available to save, the oldest file will be deleted and save new one. Even though you have extra space.</p> <p>⇒ It is possible to delete all of files or each one.</p>			

⇒ The number of saving files for capacity

	Micro SDHC Card		
Capacity	4 GByte	8 GByte	16 GByte
Captured image	128	128	128
The number of Videos (60 Second)	max 100 cuts	max 400 cuts	max 800 cuts
Video time	200 min	400 min	800 min

#### (10) Proximity Sensor

- The function which is to record and save image automatically if the sensor is detected in case of using camera with a built-in proximity sensors.
- If the sensor is detected, image will be recorded and saved automatically, but the screen does not turn on. (1 captured image/ 30sec video)
- It can detect when the sensor port is changed from HIGH condition (12V-NORMAL) to LOW condition (0V-sensor detect)
- When the sensor input run during 3 seconds in the LOW condition, Initial sensor detector is executed. Sensor detector will work again after 1 minute from standby mode. (When the Electronic album starts, the detect time for re-sensors is executed as soon as electronic album starting) At this time, count starts in standby mode only
- SENSOR1 detect → CAM1 automatic recording → If SENSOR2 detect within 1 minute from re-detect of SENSOR 1, CAM 2 recording starts. It is the same vice versa.
- SENSOR1 and CAM1 (SENSOR2 and CAM2) work together. If you install the other way, they operate in reverse.
- Please careful that a SENSOR2 can be used only if CAM2 UE pin is in OPEN(CAM2 ON) condition
- When the fuselage sensor of setup menu is in ENABLE condition, the power (12V) will be supplied (If the fuselage sensor of setup menu is in DISABLE condition, the power 12V will be shut off)
- This is operated only in the standby mode. (This work is not operated when other functions such as menu, call, monitoring and interphone are operated)
- A storage method depends on setting (Video/Still image)
- For recording images, If LED of "recording button" is pause image, LED blinks once. If it is video, LED blinks at an interval of 500m/s and it record it but LCD is turned off
- If there is a call from door or interphone, it stop to record image and operate call function
- When the sensor 2 detects it after detecting the sensor 1, the recording of sensor 1 will be stopped, then the recording of the sensor 2 will be start. And vice versa
- If there is no a SD card, Fuselage sensor does not run

## 4. GUI Function

### (1) Power On

When you turn on the product, "COMMAX" logo is displayed in the screen and beep sound comes out. After beep sound, screen is turned off and become stand-by mode.







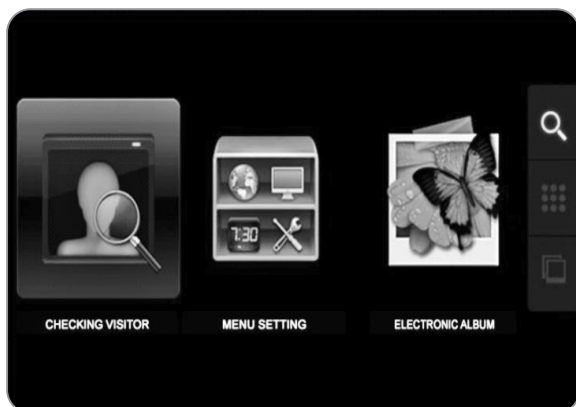

### (2) Main menu

Press Menu button at the side of the product to enter setting menu screen..  
Main menu contains checking visitors/settings/Digital album.



**Button details**









Icon	Button	Function
		Move right(Checking visitor→Settings→Digital album)
		Move left(Checking visitor←Settings←Digital album)
		Select.

**(3) Check recorded image (Checking visitor)**

Select on between video and captured image.



**Button details**

Icon	Button	Function
		Move right
		Move left
		Select.
		Move to main menu

You can check recorded video and image with quad split-screen in sequence of date.



### Button details

Icon	Button	Function
		Move to next page
		Move to previous page
		Move among Quad split-screen
		Show one image
		Move top menu

#### (4) Checking recorded image

You can see each full image by selecting one in quad split-screen. It is possible to delete each one.



#### Button details

Icon	Button	Function
		Move to next page
		Move to previous page
		Move among Quad split-screen
		Show one image
		Move top menu



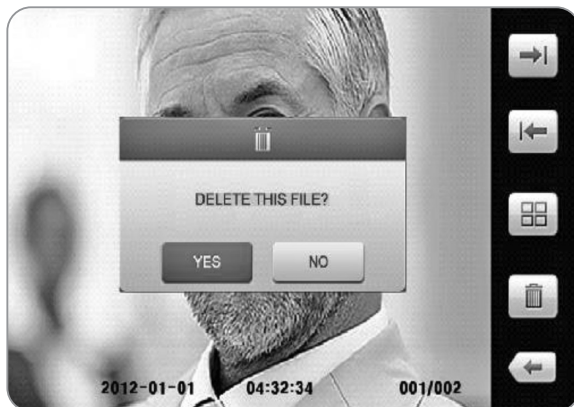

### (5) Delete image

If you implement [Current page Delete] function from Save Image check, you will see below images.



#### Button details

Button	Function
	Select [Yes]
	Select [No]
	Show next page after deleting image

## (6) Settings Menu

Time, Display, Language, Setting are adjustable.



### Button details

Icon	Button	Function
		Move right (Time→Display→Language→setting)
		Move left (Time←Display←Language←setting)
		Select
		Move top menu

### (7) Time setting

When you see saving image it can be listed the time information.

It can be settled year/month/day/hour/minute. When you set, you can change only the blue that active. If you press the button you can change the actual time.

if not supply power for more than 48 hours, It will be initialized setting the time.



#### Button details











Icon	Button	Function
		Moving the right
		Moving the left
		select
		(If you press the select button) Time increase
		(If you press the select button) Time decrease
		go to the top menu

## (8) Screen Settings

You can adjust the brightness, contrast and color etc.



### Button details

Icon	Button	Function
		Moving the right
		Moving the left
		Select a menu
		It can be changed all settings to default. All setting will be initialized by 50.
		go to the top menu

### (9) Setting the Language

You can set the language menu. (All of base setting is in English)

When you move the key, please press the select button and it will be displayed V.



#### Button details

Icon	Button	Function
		Moving the right
		Moving the left
		Select a menu
		go to the top menu

### (10) Settings menu

This menu can set Storage setting(still image/video), device initialization, automatically/ manually saving setting, proximity sensor , electronics album.

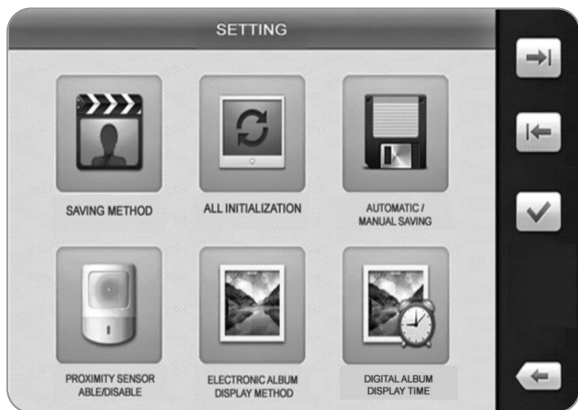

#### Button details

Icon	Button	Function
		Moving the right
		Moving the left
		Select a menu
		go to the top menu

### (11) Storage Setting

You can select saving image by calling camera. When you set the video, can make video and voice recording. If set the stop image it will be saved the just image.



#### Button details







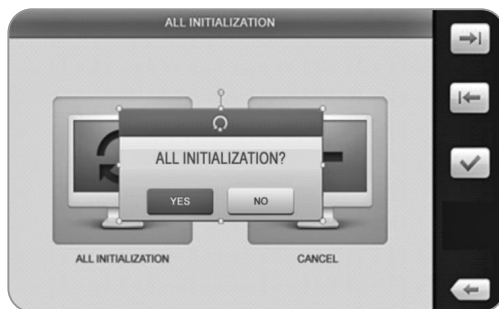
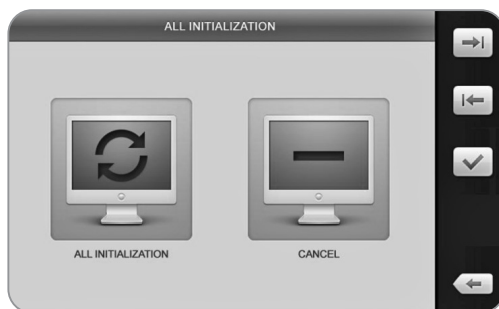

Icon	Button	Function
		Moving the right
		Moving the left
		Menu selection.
		go to the top menu

## (12) All initialization

This function can initialization mode except time function.



### Button details

Icon	Button	Function
		Moving the right
		Moving the left
		Select a menu
		go to the top menu



### (13) Automatically / manually save settings

When you save the image, you can set auto mode and manual mode.

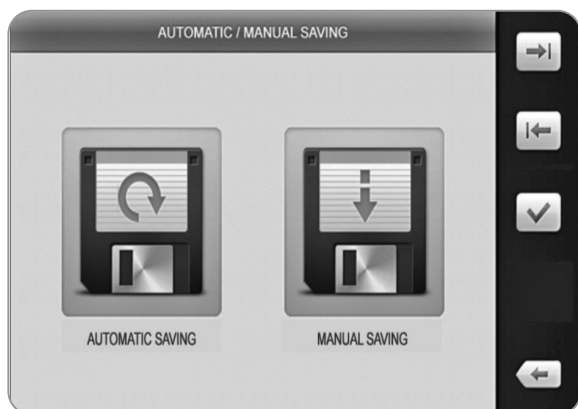

#### Button details

Icon	Button	Function
		Moving the right
		Moving the left
		Select a menu
		go to the top menu

### (14) Proximity sensors used

When person come to the camera near the proximity sensor save the image. Initial set is "DISABLE".

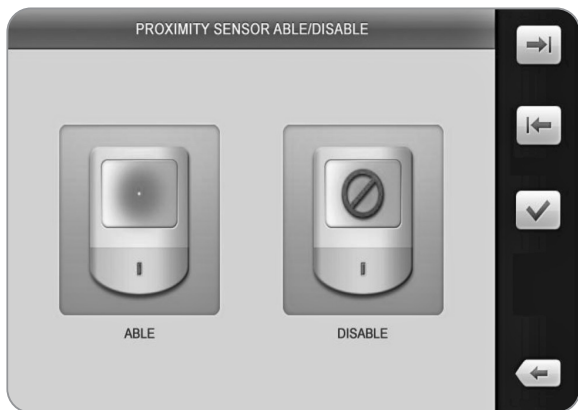

#### Button details

Icon	Button	Function
		Moving the right
		Moving the left
		Select a menu
		go to the top menu

### (15) Electronic album-effect

- E-album run to set image representation.
- No effect : when output the image and the next image also output.
- Fade-in : sprayed the form of point and output the image.
- Move : slide-image output.

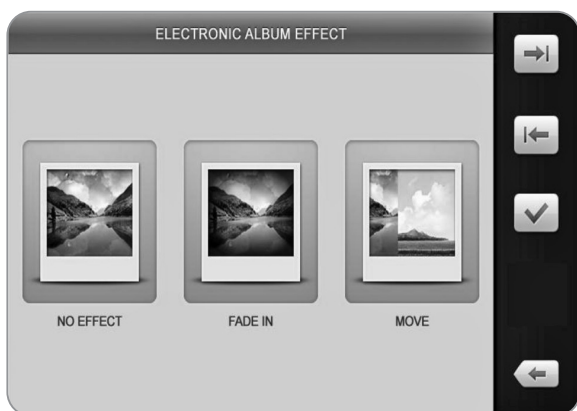

#### Button details

Icon	Button	Function
		Moving the right
		Moving the left
		Select a menu
		go to the top menu

## (16) Electronic album activation functions

If you activate electronic album, the main menu will be displayed ✓ .

If you press select menu, this menu it will be disappeared and the marking will be released. When activate the electronic album, 30 seconds after the function will be executed. The images change every 15 seconds.

If you receive call from the camera or interphone while the electric album is running, the running functions will be just stopped the camera or interphone will be functioned.

When you use other function 30seconds after the electronic album will run again.

After an event occurs, the electric album will be run automatically once. If you press image saving button in the standby mode for more than 3 seconds, the electric album can be run at one time.

The electric album function can be run only if a Micro-SD-CARD for saving images is connected and there is the image in the ALBUM folder.

### \* E-file specifications Album

- Image format : JPEG

- Image size

320x240 / 640X480 / 800X600 / 1024X768 / 1280X1024 / 1600X1200 / 1920X1200







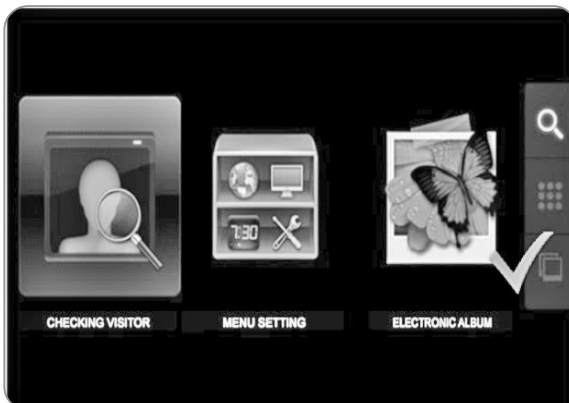

\* if you use any other resolution size , width size must be a multiple of 16.

\* If not normal specification of file the electronic album is not play.





\* If not correct specifications please change image file correctly.





**Button details**

Icon	Button	Function
		Moving the right
		Moving the left
		Select a menu
		go to the top menu

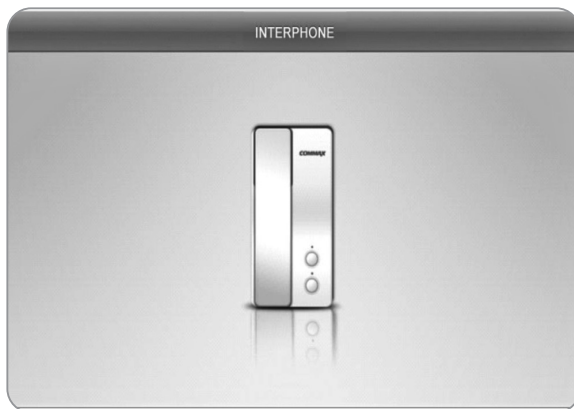

**(17) Interphone**

When you press the button  below image will pop up, and  (interphone button) and  (talk button) will blink. Then, click  (interphone button) to call the interphone. If not press the interphone button within 5seconds, it will be changed to standby mode.

**Button details**





Button	Function
	Interphone call
	Call start / end

### (18) Camera Calling

When you press the call button in Camera or press  in videophone, the image of camera and CCTV will be appeared. The left icon  tells the status of calling The right icon  is the image saving.



#### Button details





Button	Function
	Standby mode: camera monitoring Camera call and status of monitoring : camera1 / camera 2 conversion Camera calling status : connect the call
	Interphone call to a third party call
	Call start / end
	Camera calling status: Save the image manually.
	Door open When you call the camera, you can just use.

**(19) Door open.**

When you call you can press the button  of open the door and then open. The icon  will appear the screen.



**Button details**

Button	Function
	Standby mode : Camera monitoring camera call and monitoring: camera1/ camera 2 Conversion camera call status: connect the call
	Intercom call to a third party call
	Call start / end
	Camera call and monitoring status : Save the image manually
	Door open (When you call the camera, you can just use)

## 5. Wiring methods

Wiring is as bellow.

### Camera connector polarity (4wires)

- ① RED : Sound signal
- ② BLUE : GND
- ③ YELLOW : Power(+12V)
- ④ WHITE : image signal

### Sensor connector of Polarity (3 wires)

- ① RED :Power(+12V)
- ② BLUE : GND
- ③ YELLOW : sensor signal

### CCTV Connector of polarity(2wires)

- ① RED : Image signal
- ② BLUE : GND

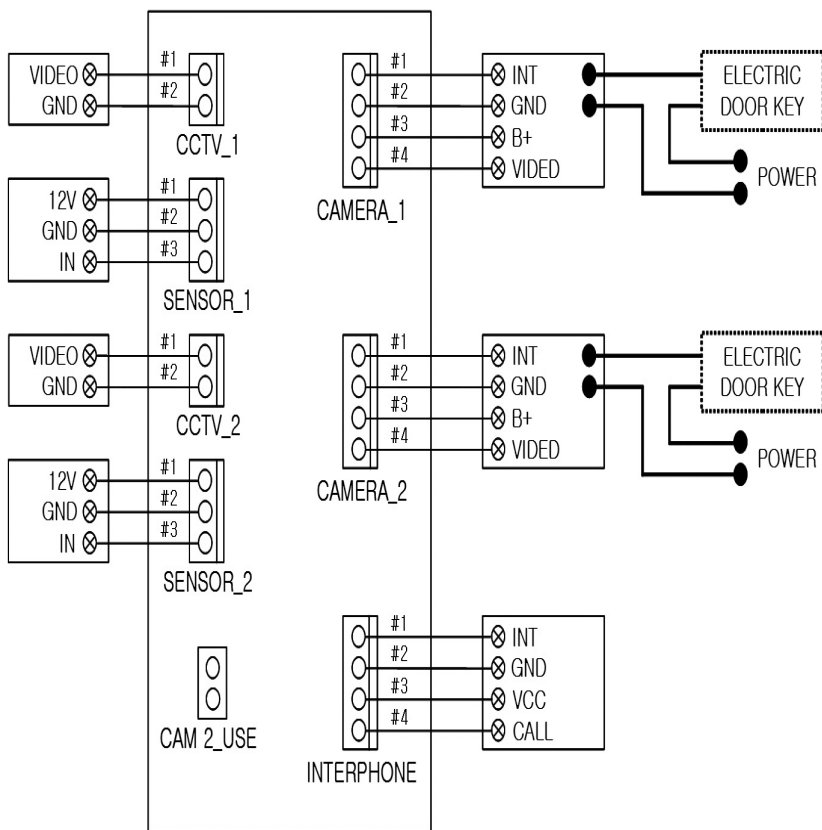



### How to connect CCTV Camera

- ♣ Please supply separate power to CCTV CAMERA.
- ♣ Please select coaxial cable depending on the distance of the camera.

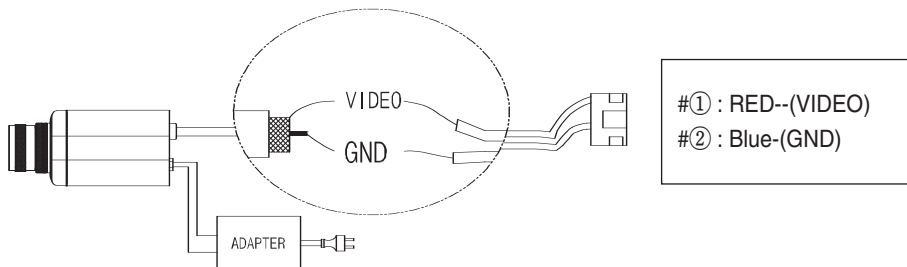

## 6. Components

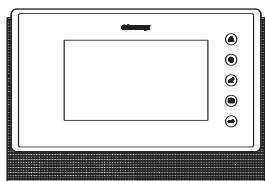

① Body of CDV-70UM

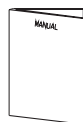

② Manual

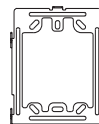

③ Bracket for wall mount



④ 2P(2EA)  
Connector

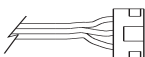

⑤ 3P(2EA)  
Connector

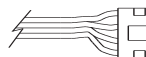

⑥ 4P(3EA)  
Connector

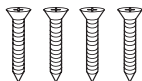

⑦ T4 X 18(4EA)  
Screw for Wall mount



⑧ M3 X 6(1EA)  
Screw for body



⑨ 2P SHUNT  
(Only No. 1 camera is available  
if you insert 2P shunt(short pin))



## 7. Caution in use

1. Turn on the power switch.
2. Please contact your local agent for product maintenance when you have a problem in use of CDV-70UM
3. For your safety, power switch with a safety device must be used in your building.
4. Unplug before installing or repairing the product.
5. Unplug when you connect monitor with door cameras.



## 8. Miscellaneous

- Please carefully read this User's Guide before calling service man  
After checking the entire check list, please contact customer service center.  
We will do our best to make you satisfy with our services.



## 9. Specification

MODEL	CDV-70UM		
Wiring	Door camera 4 wires (Polarity), CCTV 2wires(Polarity), Interphone 4wires(Polarity)		
Voltage	100-240V~, 50/60 Hz		
Power Consumption	Standby : 2.6W , in operation : 15W		
Communication	Full duplex (Hands-Free)		
Monitor	17.78Cm(7") TFT-DIGITAL LCD		
Ringng	- Entrance : Electronic chime (3 call 2times) - Interphone : Electron buzzer		
Video receiving period	Standby : 30 ±5sec , response : 60 ±5sec		
Distance	0.5mm	0.65mm	0.8mm
	28m	50m	70m
Temperature	0 ~ +40°C (32°F ~ 104°F)		
Dimensions(mm)	276(W) X 185(H) X 33(D)		

# **COMMAX**

## **COMMAX Co.,Ltd.**

513-11, Sangdaewon-dong, Jungwon-gu, Seongnam-si, Gyeonggi-do, Korea

Int'l Business Dept. Tel. : +82-31-7393-540~550 Fax. : +82-31-745-2133

Web site : [www.commax.com](http://www.commax.com)

PM0270UM0010

*Printed In Korea / 2012.10.104*